

 **SYNERGEE<sup>®</sup>**

# SMITH MACHINE

## SF2300 SERIES

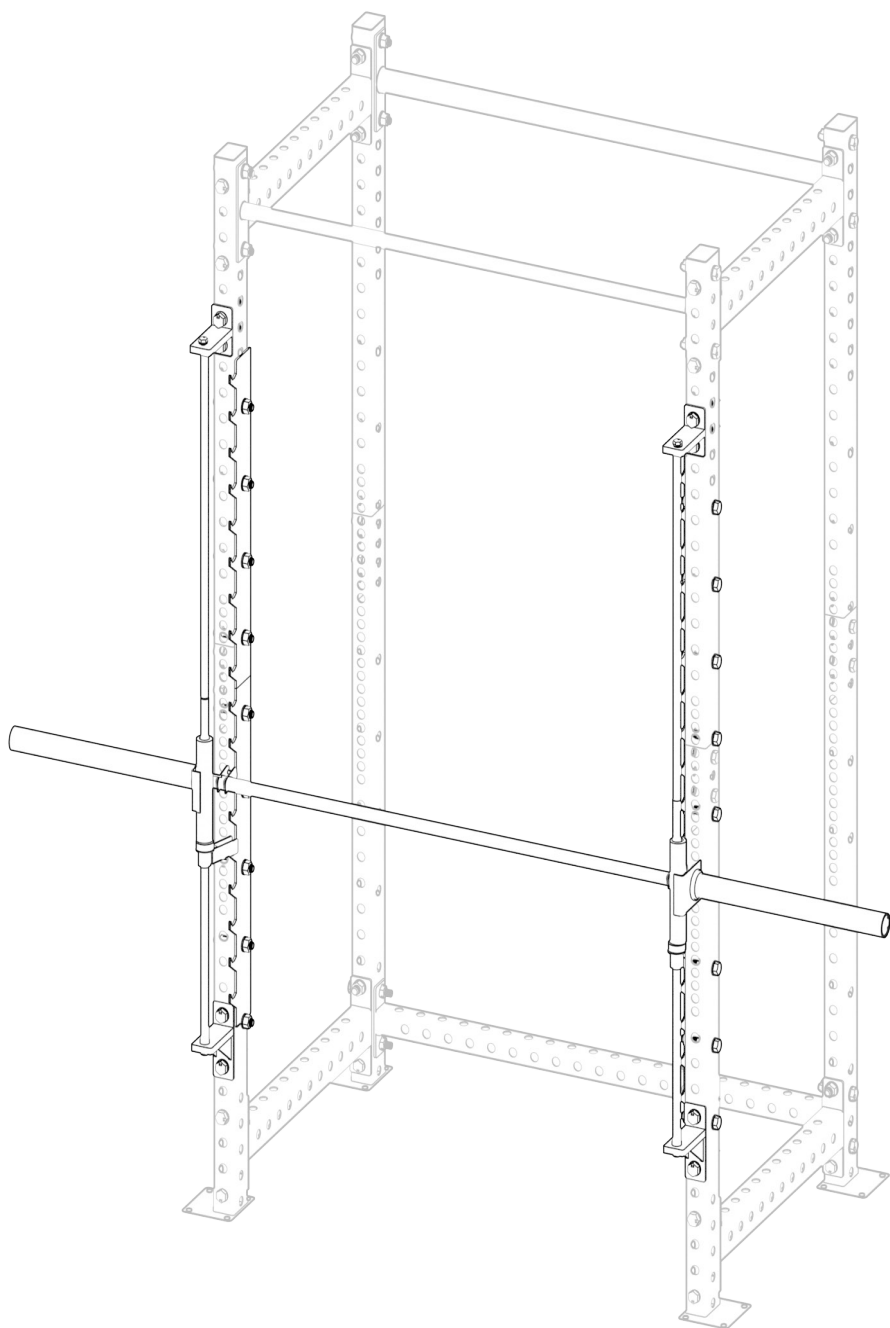



## **ATTENTION**

**ENSURE POWER RACK  
UPRIGHTS ARE EQUALLY  
SPACED & BOLTED TO  
THE FLOOR BEFORE SMITH  
MACHINE INSTALLATION**

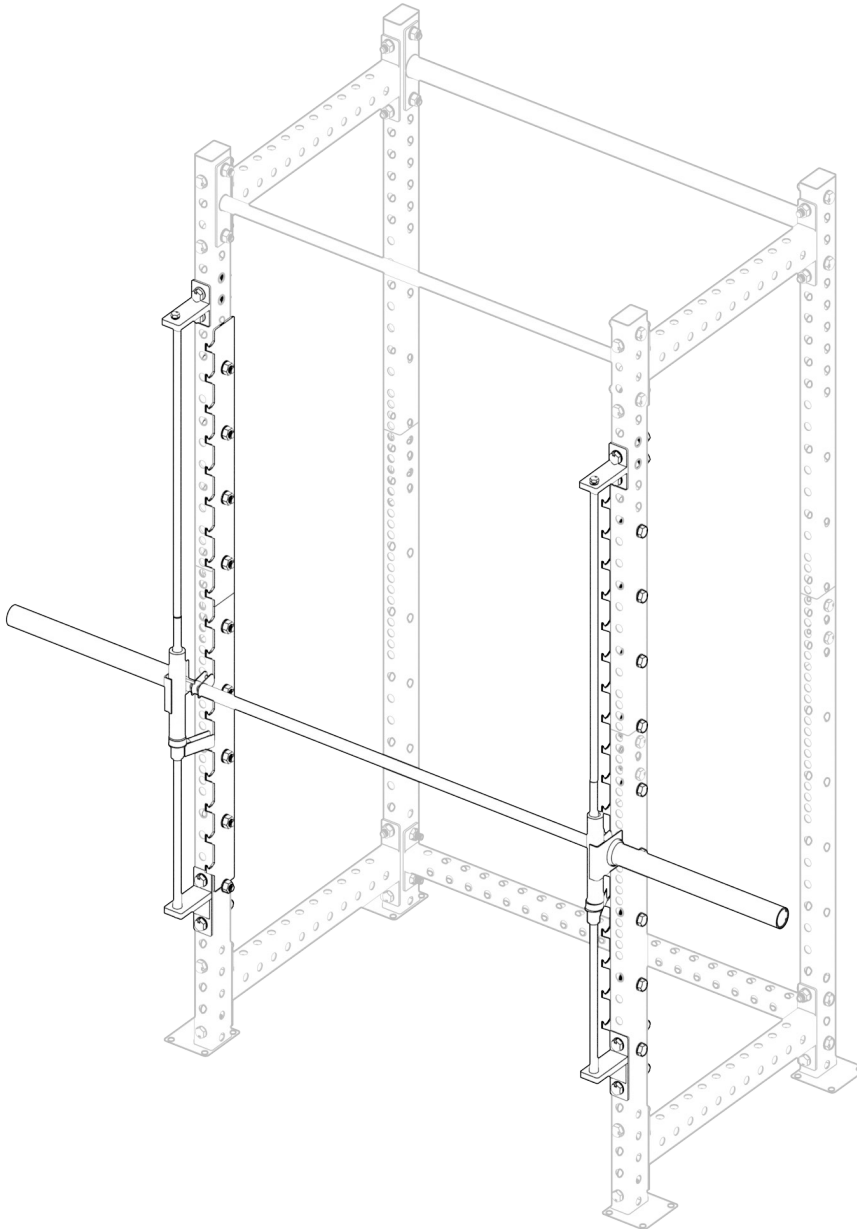



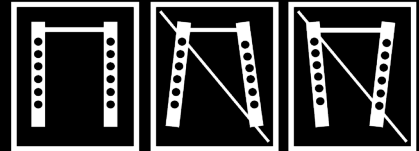

## **! IMPORTANT**

**ENSURE RACK IS LEVEL  
TO THE FLOOR BY  
MEASURING TOP AND  
BOTTOM SPACING IS  
EQUAL.**

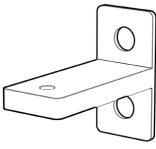
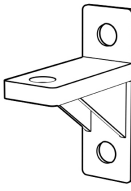
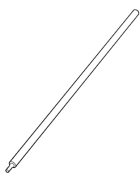

# PARTS LIST

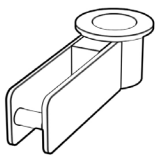
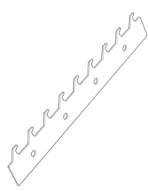
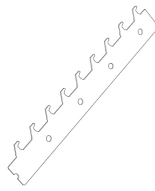
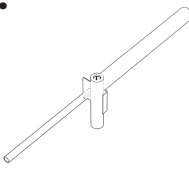
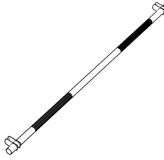
IF ANY PIECES ARE MISSING, PLEASE CONTACT US IMMEDIATELY:  
HELLO@SYNERGEEFITNESS.COM OR 1.855.217.7136

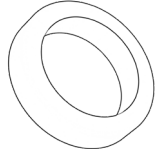
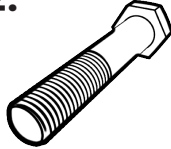
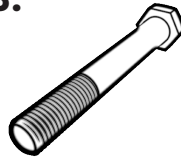
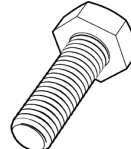
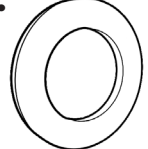
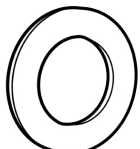
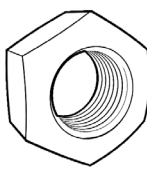
<p><b>1.</b></p>  <p><b>2300-21</b></p>	<p><b>QTY</b> x2</p>	<p><b>2.</b></p>  <p><b>2300-22</b></p>	<p><b>QTY</b> x2</p>	<p><b>3.</b></p>  <p><b>2300-23-1</b></p>	<p><b>QTY</b> x2</p>	<p><b>4.</b></p>  <p><b>2300-23-2</b></p>	<p><b>QTY</b> x2</p>	<p><b>5.</b></p>  <p><b>2300-27</b></p>	<p><b>QTY</b> x2</p>
<p><b>6.</b></p>  <p><b>2300-24-1</b></p>	<p><b>QTY</b> x2</p>	<p><b>7.</b></p>  <p><b>2300-24-2</b></p>	<p><b>QTY</b> x2</p>	<p><b>8.</b></p>  <p><b>2300-25</b></p>	<p><b>QTY</b> x2</p>	<p><b>9.</b></p>  <p><b>2300-26</b></p>	<p><b>QTY</b> x1</p>	<p><b>10.</b></p>  <p><b>2300-00-08</b></p>	<p><b>QTY</b> x2</p>
<p><b>11.</b></p>  <p><b>2300-00-10</b></p>	<p><b>QTY</b> x2</p>	<p><b>12.</b></p>  <p><b>M16x80 HEX SCREW</b></p>	<p><b>QTY</b> x18</p>	<p><b>13.</b></p>  <p><b>M16x110 HEX SCREW</b></p>	<p><b>QTY</b> x8</p>	<p><b>14.</b></p>  <p><b>M10x30 HEX SCREW</b></p>	<p><b>QTY</b> x4</p>	<p><b>15.</b></p>  <p><b>M16 WASHER</b></p>	<p><b>QTY</b> x52</p>
<p><b>16.</b></p>  <p><b>M10 WASHER</b></p>	<p><b>QTY</b> x4</p>	<p><b>17.</b></p>  <p><b>M16 NUT</b></p>	<p><b>QTY</b> x26</p>						

# HARDWARE SIZING CHART

**M16x110  
HEX SCREW**

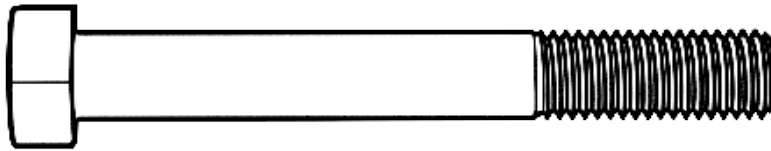

STEPS

**2-5**

**M16x80  
HEX SCREW**

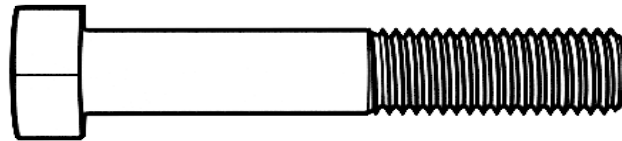

STEPS

**1**

**M10x30  
HEX SCREW**

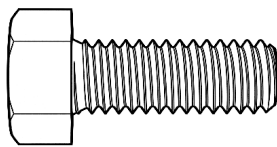

STEPS

**3-7**

## WASHERS

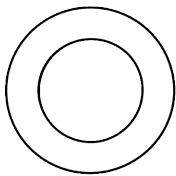

**M10 WASHERS**

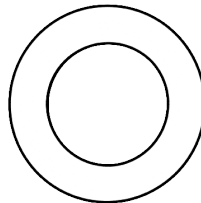

**M16 WASHERS**

## NUTS

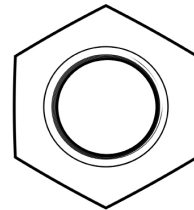

**M16 NUT**

# ASSEMBLY

## STEP: 1

### STEP PART GUIDE

#	PART NAME	QTY
6.	2300-24-1	2
7.	2300-24-2	2
12.	M16x80 HEX SCREW	18
15.	M16 WASHER	36
17.	M16 NUT	18

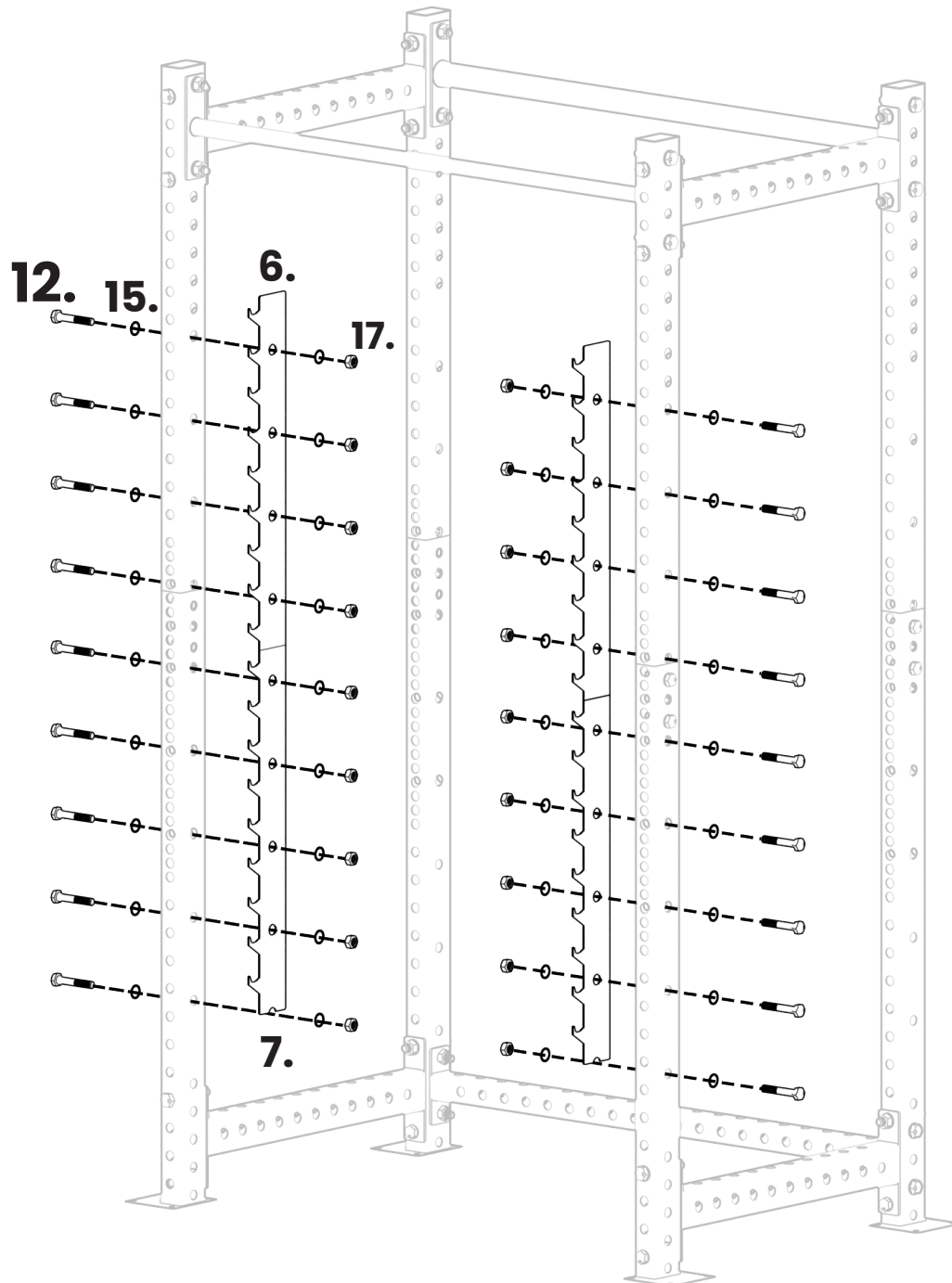

# ASSEMBLY

## STEP: 2

# STEP PART GUIDE

#	PART NAME	QTY
2.	2300-22	2
13.	M16x110 HEX SCREW	4
15.	M16 WASHER	8
17.	M16 NUT	4

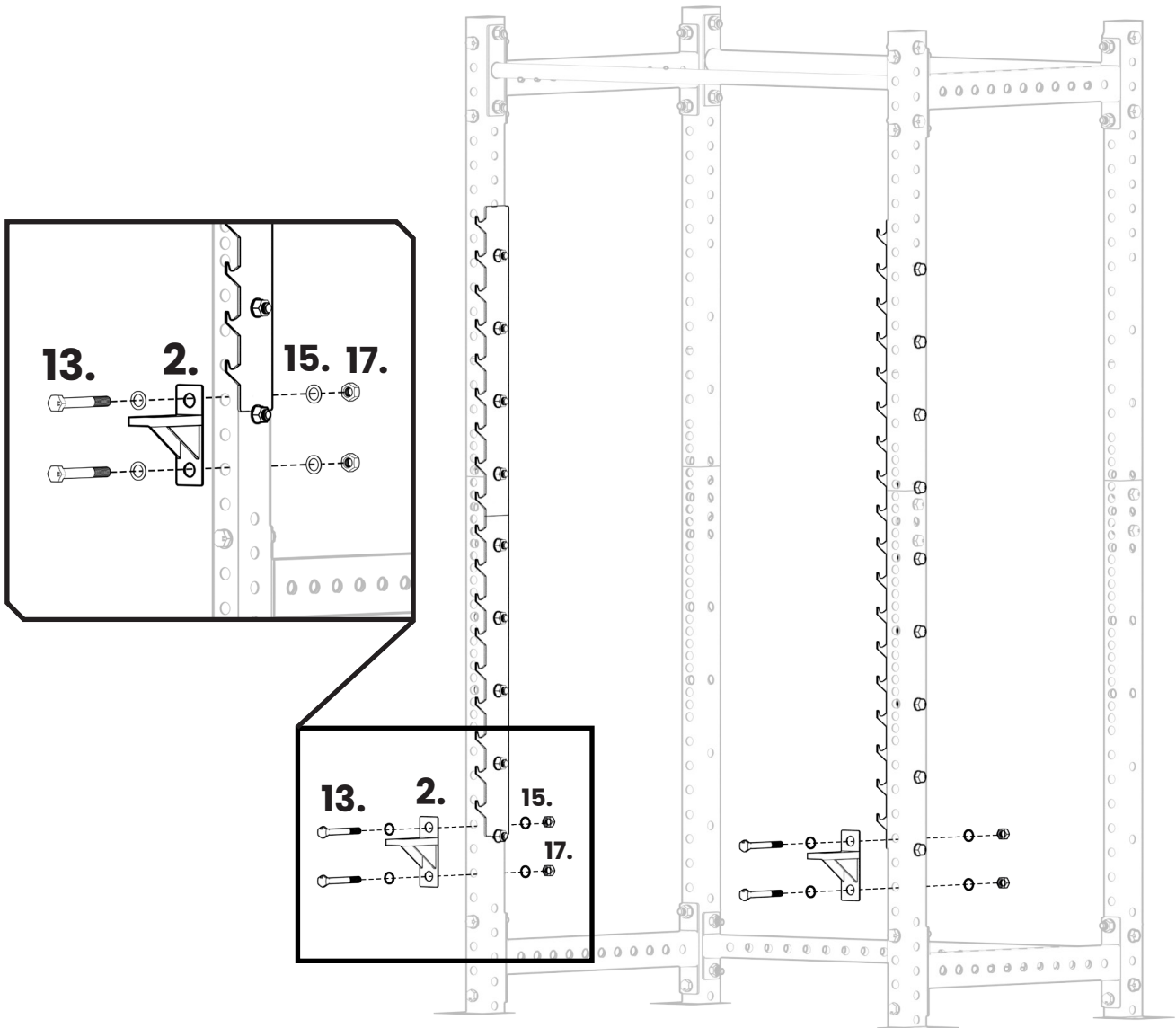

# ASSEMBLY

## STEP: 3

### STEP PART GUIDE

#	PART NAME	QTY
4.	2300-23-2	2
14.	M10x30 HEX SCREW	2
16.	M10 WASHER	2



**ENSURE SCREW IS FULLY SECURE TO POLE**

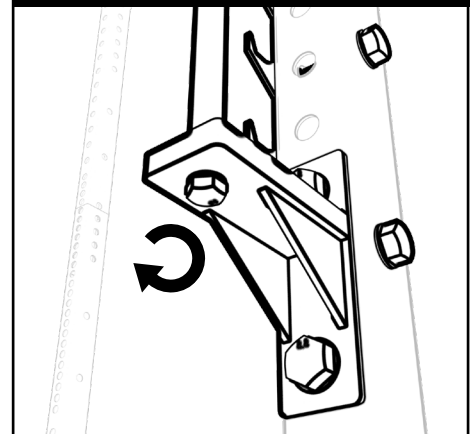

# ASSEMBLY

## STEP: 4

### STEP PART GUIDE

#	PART NAME	QTY
10.	2300-00-08	2
5.	2300-27	2

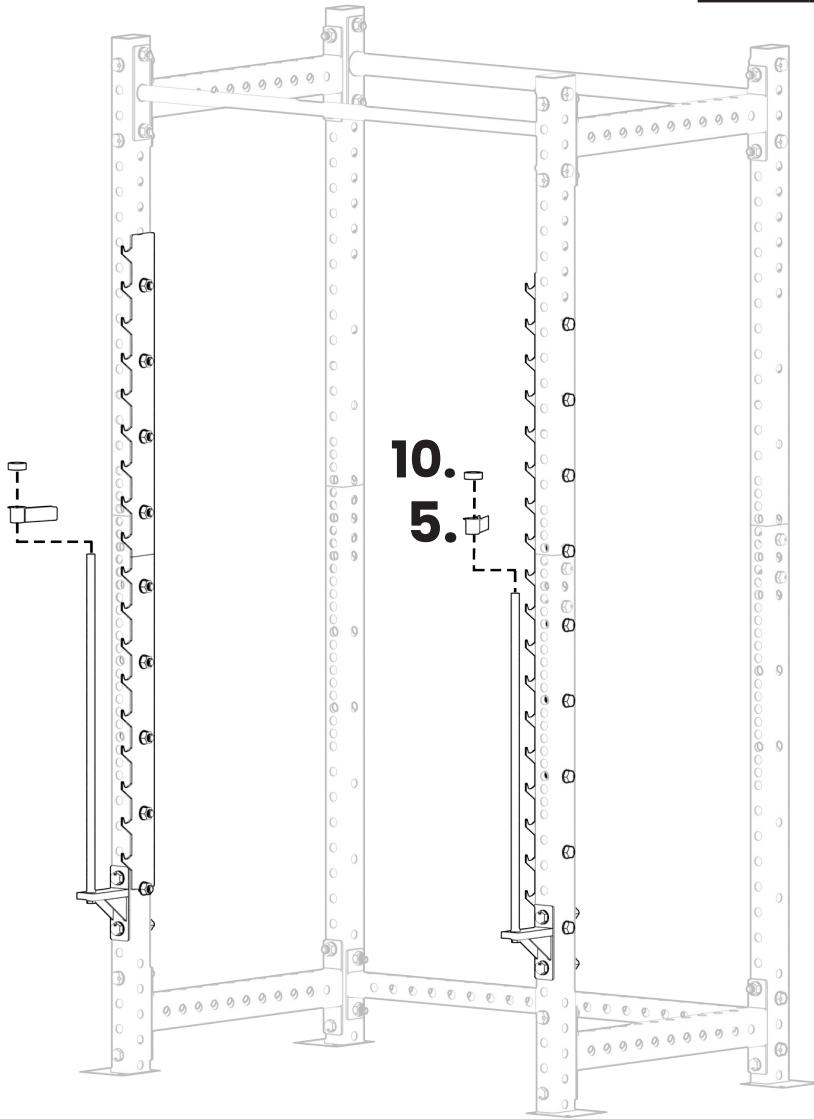

**PLACE STOPPER ON 5TH RUNG FROM THE BOTTOM TO IMPROVE BAR INSTALLATION.**

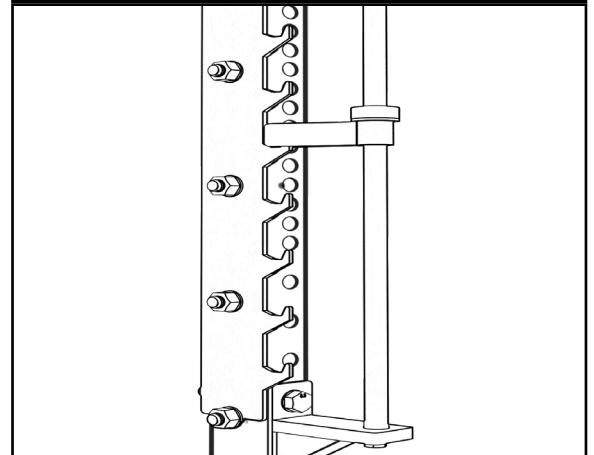



# ASSEMBLY

## STEP: 5

### STEP PART GUIDE

#	PART NAME	QTY
8.	2300-25	2
9.	2300-26	1
11.	2300-00-10	2

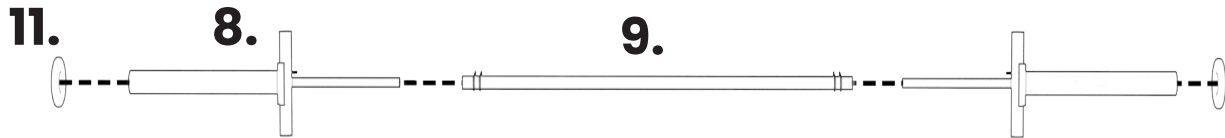

## ! ATTENTION

**BAR MUST BE INSTALLED ON BOTH ENDS AT THE SAME LEVEL EVENLY TO AVOID BINDING.**

**RECOMMEND 2 PERSON INSTALLATION.**

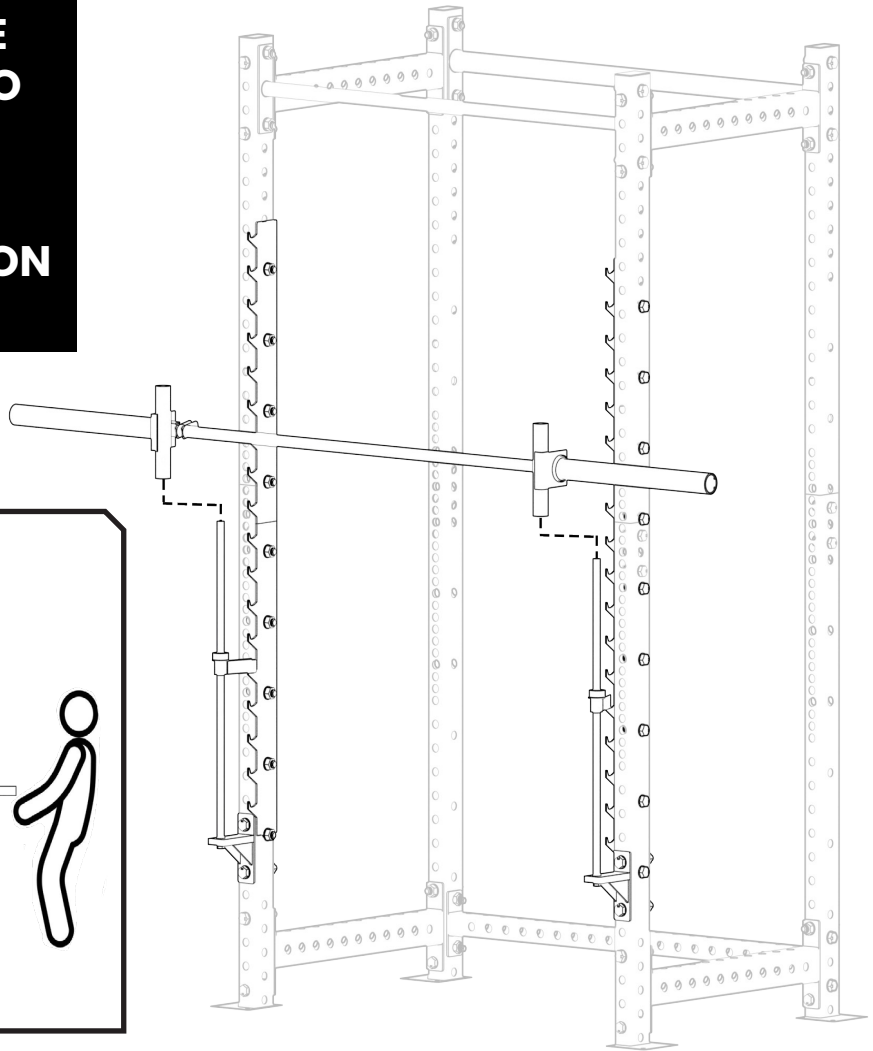
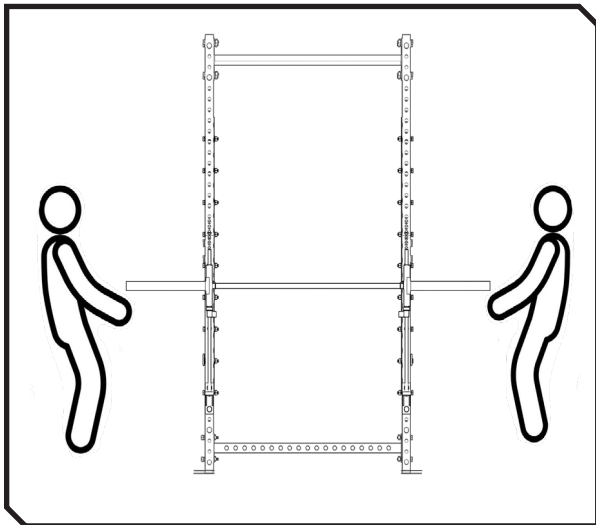
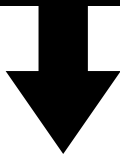

# ASSEMBLY

## STEP: 6

# STEP PART GUIDE

#	PART NAME	QTY
3.	2300-23-1	2

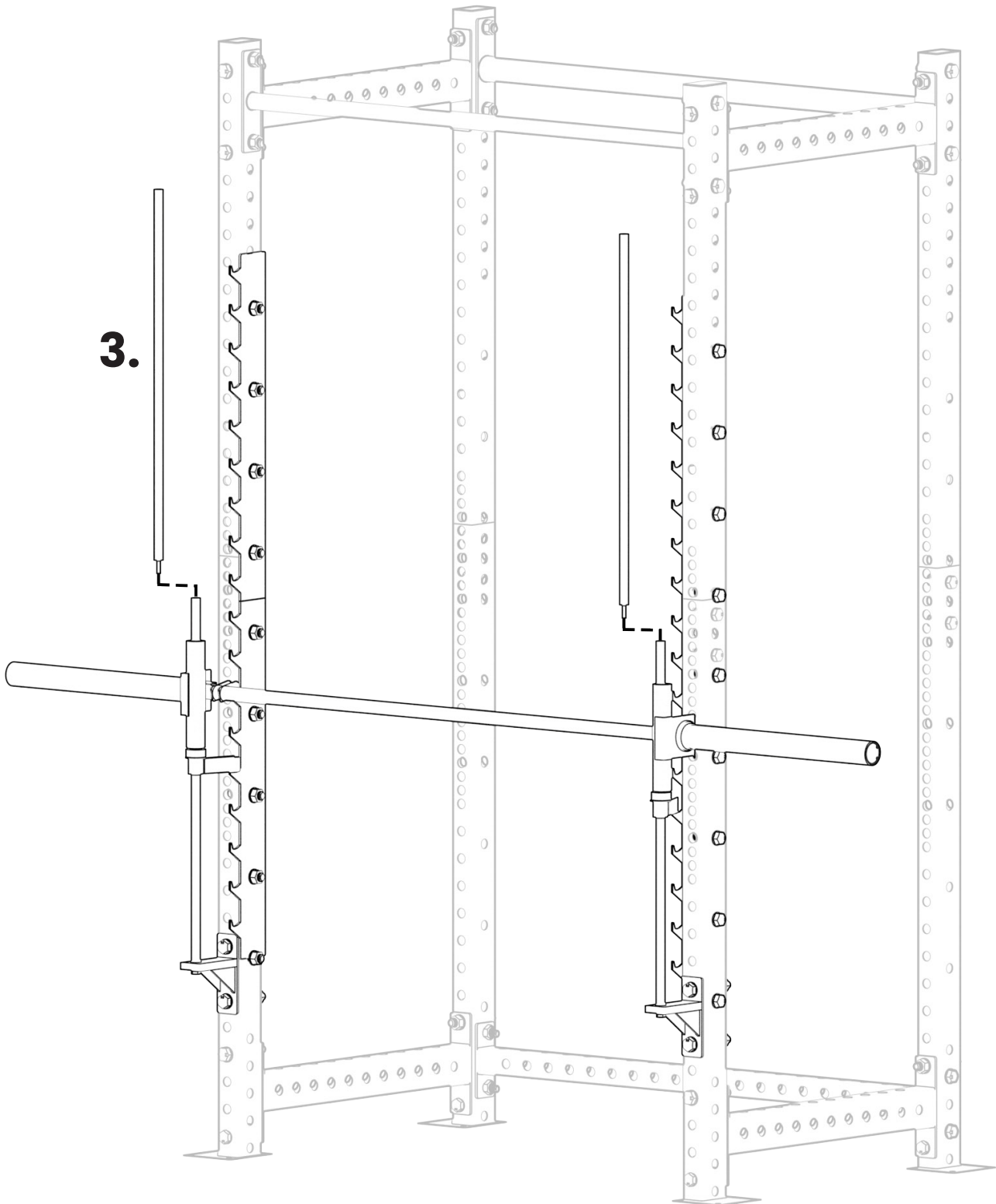

# ASSEMBLY

## STEP: 7

# STEP PART GUIDE

#	PART NAME	QTY
1.	2300-21	2
13.	M16x110 HEX SCREW	4
15.	M16 WASHER	8
17.	M16 NUT	4

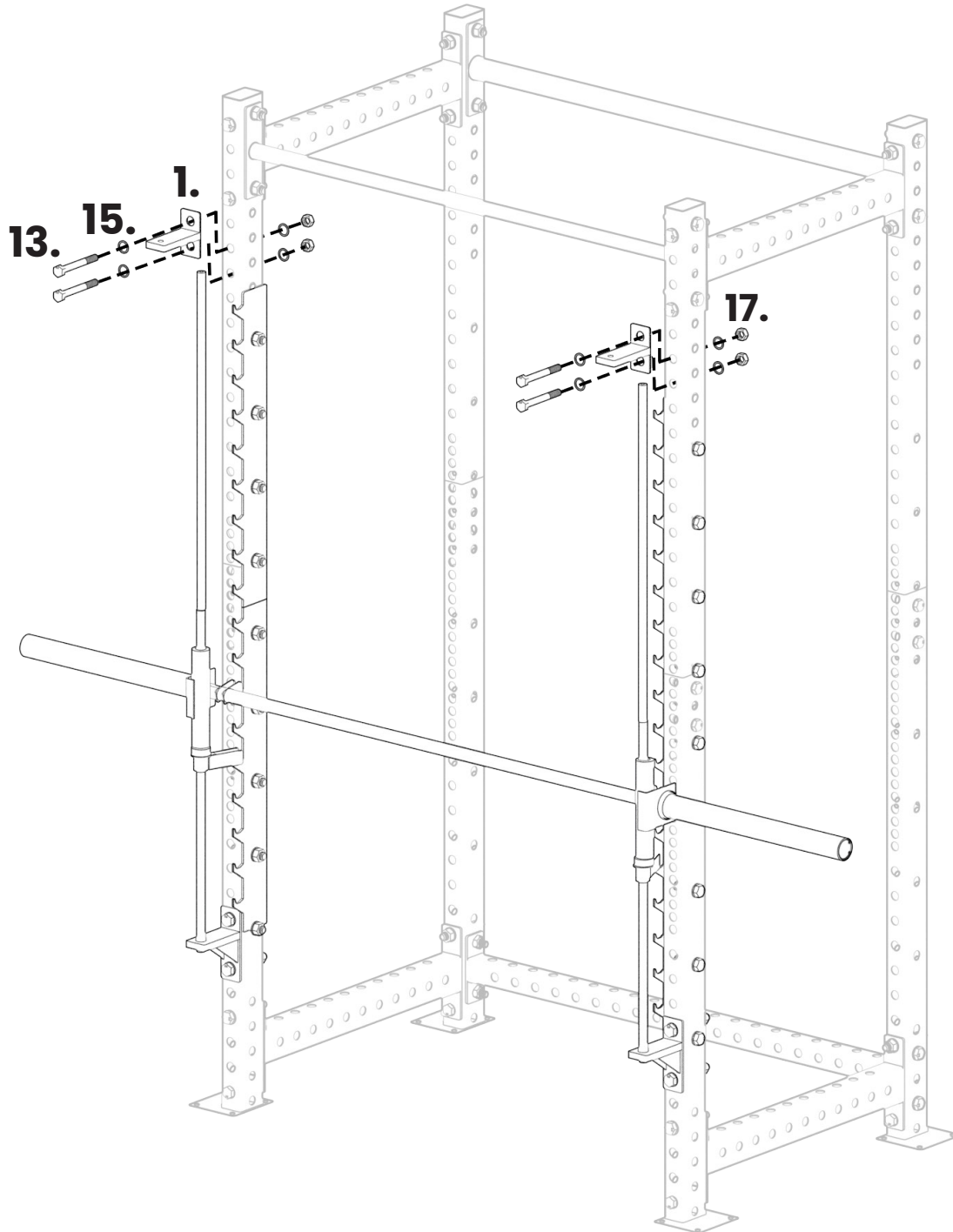

# ASSEMBLY

## STEP: 8

# STEP PART GUIDE

#	PART NAME	QTY
14.	M10x30 HEX SCREW	2
16.	M10 WASHER	2

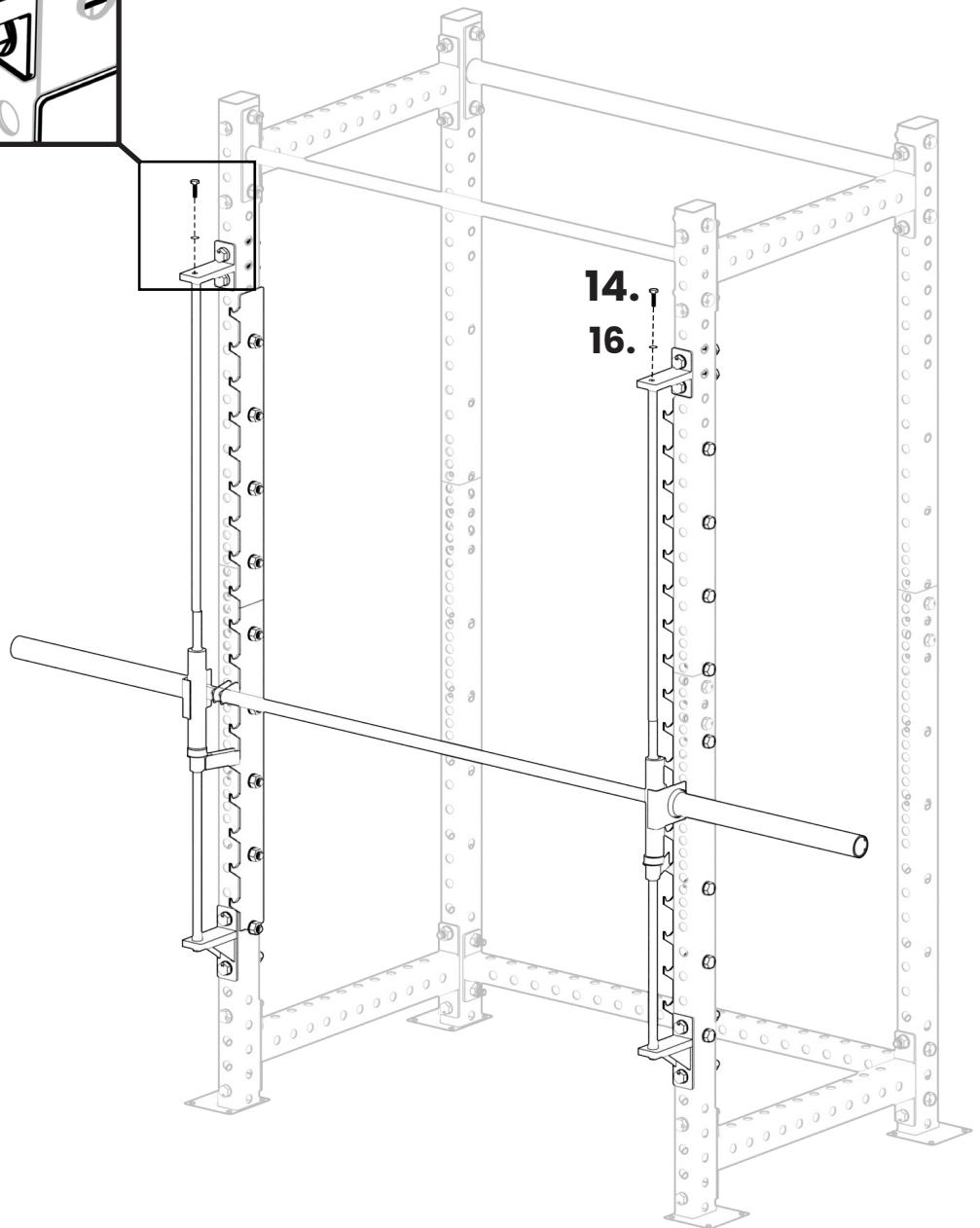
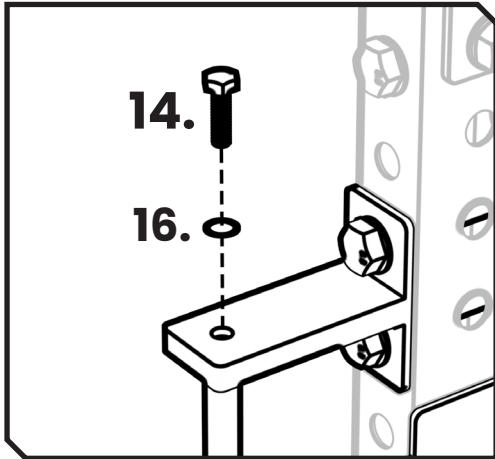

# ASSEMBLY

## STEP: 9

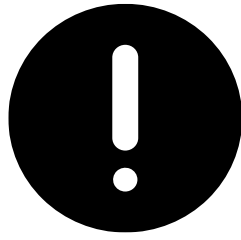

### **ATTENTION**

**POWER RACK MUST BE SECURED TO THE FLOOR FOR SMITH MACHINE TO OPERATE PROPERLY**

